



# Flygt propeller pumps

FOR COST-EFFECTIVE TRANSPORT OF LARGE VOLUMES

**FLYGT**  
a xylem brand

# Compact, adaptable, easy-to-install propeller pumps



## Broad capacity range

- Ratings up to 578 kW or 775 hp
- Flow up to 7200 l/s or 120 000 USgpm
- All products factory-tested

**Flygt propeller pumps are designed to transport large volumes of water at low heads. The slim profile of these pumps provides a considerably smaller pump station footprint than that of non-submersible pumps.**

Count on Flygt submersible propeller pumps from Xylem for compact, low-cost pumping stations that do not require any superstructure.

### Quick, low-cost installation

Only a few minutes are required to install or remove Flygt propeller pumps from the pump station. No fastening bolts are required. These smart economic alternatives operate submerged in the pumped liquid. That makes them less complex to install and enables the motors to run cooler and more quietly than non-submersible propeller pumps.

### Robust and reliable

Every Flygt propeller pump is tested in the factory to ensure high performance and premium quality. Like all Flygt products, Flygt propeller pumps deliver solid cost-effective performance that has been proven for more than 40 years in applications such as:

- Storm water
- WWTP Effluent
- Water intakes
- Flood control
- Amusement park attractions
- Surf riders



## Superior design

- Compact
- Based on patented N-technology
- Self-cleaning capabilities
- Reliable
- Modular design
- Fewer unplanned service calls
- Cable protection system

# Self-cleaning design saves money

## Technology leadership

Flygt propeller pumps feature patented Flygt N-technology, which is renowned for its self-cleaning capabilities and sustained high efficiency. Using our vast fluid handling knowledge, Xylem has adapted proven N-technology to our broad range of Flygt propeller pumps.

## Self-cleaning components

To prevent clogging, Flygt propeller blades feature signature N-technology with the backswept design of the leading edge. This sweeps debris away from the propeller along the relief groove located in the wear ring. Guide vanes help force debris out of the pump housing by the strong turbulent flow created within.

## Solid hydraulic performance

All of these features work together to increase sustained high efficiency while reducing energy costs and downtime.

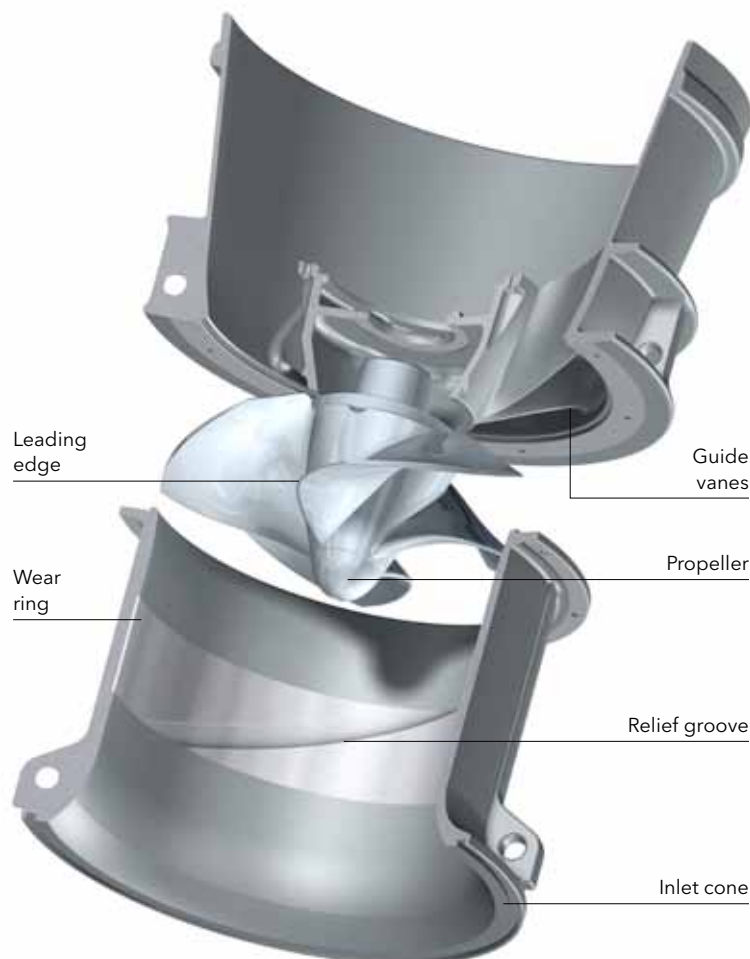

Hydraulic design using patented Flygt N-technology, which is available for Flygt 7061, 7065, 7081, 7101, 7105, 7121 and 7125 propeller pumps.

## Zero leakage into the motor cavity

The Active Seal™ system is a patented zero-leakage double-seal system that actively prevents liquid from entering the motor cavity, thereby reducing the risk for bearing and stator failure.

Active Seal enhances sealing reliability, reduces downtime and requires fewer unscheduled maintenance checks.



The unique inner seal of Active Seal has laser-cut spiral grooves that act as a micro-pump.

# High quality through robust design

## BETTER HEAT TRANSFER

Our specially designed and manufactured motor provides enhanced cooling because heat losses are concentrated around the stator. Trickle impregnated with Class H insulating resin, the stator windings are rated at 180°C (355°F) and enable up to 15 starts per hour.

## COMPLIANCE

Each pump is tested and approved in accordance with national and international standards, including IEC 34-1 and CSA. Pumps are available in explosion-proof versions for use in hazardous environments, and are approved by the Factory Mutual, European Standard and IEC.



## CABLE ENTRY

The cable entry provides sealing and strain relief functions for safe installation.

## SENSORS

Thermal sensors in the stator windings prevent overheating, and an analogue temperature sensor monitors the lower bearing. The stator housing and the junction box are equipped with leakage sensors. The sensors decrease the risk of bearing and stator failure.

## LONG-LIFE BEARINGS

Durable bearings provide a minimum service life of 100,000 hours.

## ENDURING SEALS

Two sets of mechanical shaft seals work independently for double security. The Active Seal™ system offers increased sealing reliability and zero leakage into the motor, thereby reducing the risk of bearing and stator failure.

## Installation examples

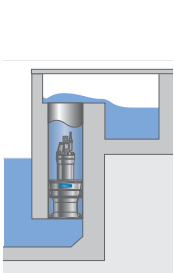

In concrete structure: For pumping to channel. No check valve is required.

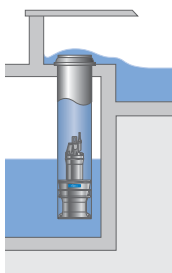

In manufactured column: For pumping to channel. No check valve is required.

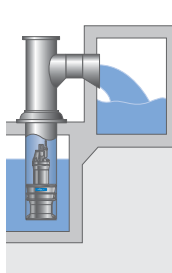

With a discharge pipe and free outlet.

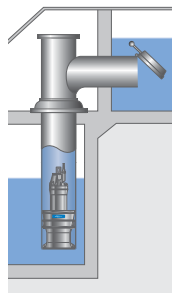

With submerged outlet and flap valve.

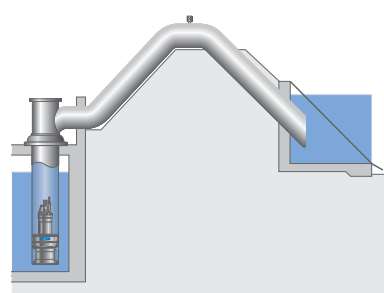

With a siphon.

# Wide range of propeller pumps

The Flygt propeller pump range includes a wide selection of models that handle capacities from 4,000 up to 120,000 USgpm. Our standardized pump station components give you greater flexibility to tailor a solution to your requirements and reduce your construction and installation costs.



## Performance range, 50 Hz

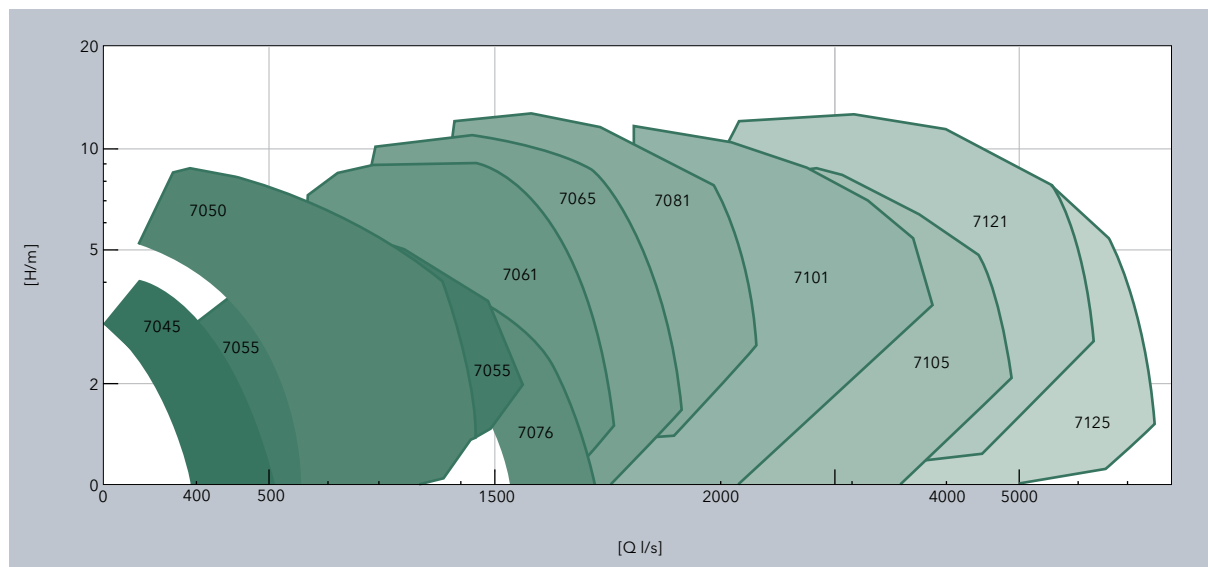

## Power ratings and sizes

Model	Rating, kW at 50 Hz	Column diameter, mm
7045	11-22	700
7050	27-55	700
7055	13-55	800
7061	46-160	800
7065	40-200	800
7076	37-55	1,000
7081	55-200	1,000
7101	40-300	1,200
7105	90-320	1,200
7121	200-575	1,400
7125	200-500	1,400

# Solutions engineered to your specific requirements

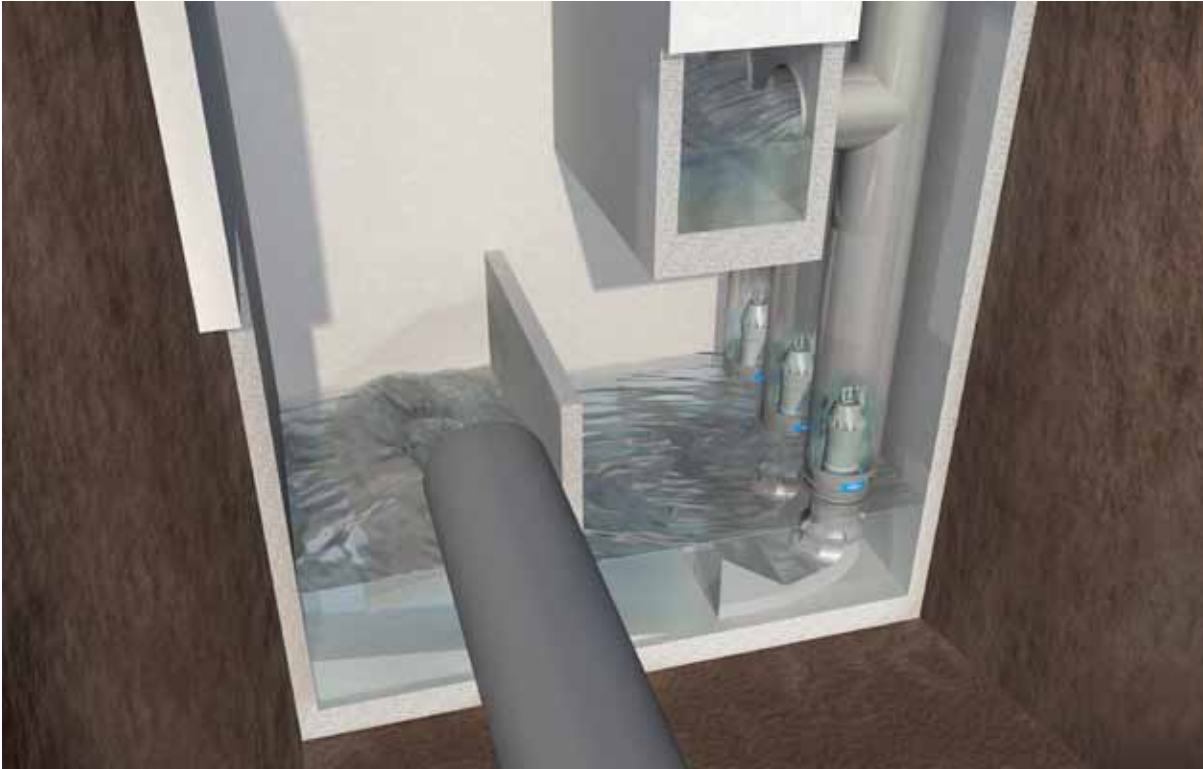

## No two pump stations are alike

Flygt propeller pumps can be configured to your specific requirements. Our engineers work closely with you, from design and system analysis to selection of product and installation equipment. This enables us to deliver reliable and cost-effective pumping solutions.

### Monitoring and control: Smart options empower operations

*Flygt MiniCAS* is a supervision relay for stator temperature and leakage sensors designed for the smaller Flygt propeller pumps.

*Flygt MAS 711* is a protective monitoring system for medium and large capacity Flygt propeller pumps.

Trouble free integration. All Flygt monitoring and control equipment integrates easily into any SCADA control system.



Flygt MiniCAS



Flygt MAS 711

# Supporting your business, every step of the way



## Extensive monitoring and control

We supply hardware and software for complete process systems - from individual pump drives, starters, sensors and controllers to system software and scalable **SCADA** systems.



## Genuine Flygt spare parts and warranty

When downtime isn't an option, rely on our global service network to deliver genuine Flygt spare parts to you - quickly and efficiently. All Flygt spare parts are backed by a solid 20-year availability guarantee.

## Extensive engineering know-how

Xylem has extensive knowledge of fluid dynamics and vast practical experience in designing, operating and maintaining efficient wastewater transport systems.

We provide a broad range of engineering services, including:

- System analysis and calculations
- Sump design
- Water hammer calculations
- Pump start analysis
- Transient analysis
- Computational Fluid Dynamics (CFD)
- Scale model testing

In short, we can assist you with everything you need for optimal performance and economical, energy-efficient operation.

## Empower your system

With Flygt monitoring and control products, you can control and optimize the performance of every component of your system. This helps reduce stress on pumps, valves and mains, enable reliable, efficient operation and prolong service lifetime.

## Support for your Flygt pumps

Our global network of local service centers and service partners, provide integrated services to support safe, efficient and reliable operation. To ensure trouble-free operation and minimal downtime, count on us for quick, professional response and quality maintenance services, using genuine Flygt spare parts.

# Xylem ['zīləm]

- 1) The tissue in plants that brings water upward from the roots
- 2) A leading global water technology company

We're 12,000 people unified in a common purpose: creating innovative solutions to meet our world's water needs. Developing new technologies that will improve the way water is used, conserved, and re-used in the future is central to our work. We move, treat, analyze, and return water to the environment, and we help people use water efficiently, in their homes, buildings, factories and farms. In more than 150 countries, we have strong, long-standing relationships with customers who know us for our powerful combination of leading product brands and applications expertise, backed by a legacy of innovation.

For more information on how Xylem can help you, go to [xylem.com](http://xylem.com).



Flygt is a brand of Xylem. For the latest version of this document and more information about Flygt products visit [www.flygt.com](http://www.flygt.com)